

Standard Rectifier

3~ Rectifier	
V_{RRM}	= 1200 V
I_{DAV}	= 40 A
I_{FSM}	= 370 A

3~ Rectifier Bridge

Part number

GUO40-12NO1

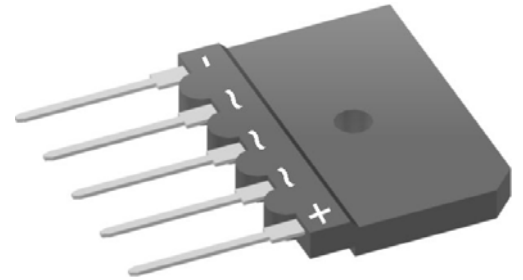

Backside: isolated

 E326641

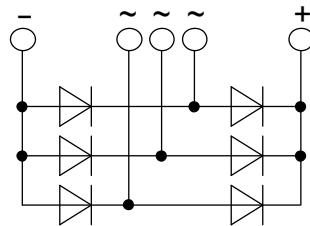

Features / Advantages:

- Low forward voltage drop
- Planar passivated chips
- Easy to mount with one screw
- Space and weight savings

Applications:

- Supplies for DC power equipment
- Input rectifiers for PWM inverter
- Battery DC power supplies
- Field supply for DC motors

Package: GUPP

- Isolation Voltage: 2500V~
- Industry standard outline
- RoHS compliant
- Epoxy meets UL 94V-0
- Soldering pins for PCB mounting
- Base plate: Plastic overmolded tab
- Reduced weight

Rectifier				Ratings				
Symbol	Definition	Conditions		min.	typ.	max.	Unit	
V_{RSM}	max. non-repetitive reverse blocking voltage					1300	V	
V_{RRM}	max. repetitive reverse blocking voltage					1200	V	
I_R	reverse current	$V_R = 1200$ V	$T_{VJ} = 25^\circ\text{C}$			40	μA	
		$V_R = 1200$ V	$T_{VJ} = 150^\circ\text{C}$			1.5	mA	
V_F	forward voltage drop	$I_F = 10$ A	$T_{VJ} = 25^\circ\text{C}$			1.06	V	
						1.28	V	
		$I_F = 30$ A	$T_{VJ} = 150^\circ\text{C}$			0.92	V	
						1.23	V	
I_{DAV}	bridge output current	$T_C = 90^\circ\text{C}$ rectangular $d = \frac{1}{3}$	$T_{VJ} = 175^\circ\text{C}$			40	A	
V_{FO}	threshold voltage					0.74	V	
r_F	slope resistance					16.3	m Ω	
		} for power loss calculation only						
R_{thJC}	thermal resistance junction to case					4.3	K/W	
R_{thCH}	thermal resistance case to heatsink				0.50		K/W	
P_{tot}	total power dissipation			$T_C = 25^\circ\text{C}$		35	W	
I_{FSM}	max. forward surge current	$t = 10$ ms; (50 Hz), sine	$T_{VJ} = 45^\circ\text{C}$			370	A	
						400	A	
		$t = 8,3$ ms; (60 Hz), sine	$V_R = 0$ V	$T_{VJ} = 150^\circ\text{C}$			315	A
							340	A
I^2t	value for fusing	$t = 10$ ms; (50 Hz), sine	$T_{VJ} = 45^\circ\text{C}$			685	A ² s	
						665	A ² s	
		$t = 8,3$ ms; (60 Hz), sine	$V_R = 0$ V	$T_{VJ} = 150^\circ\text{C}$			495	A ² s
							480	A ² s
C_J	junction capacitance	$V_R = 400$ V; $f = 1$ MHz	$T_{VJ} = 25^\circ\text{C}$		10		pF	

Package GUPP		Ratings				
Symbol	Definition	Conditions	min.	typ.	max.	Unit
I_{RMS}	RMS current	per terminal			70	A
T_{stg}	storage temperature		-55		150	°C
T_{vj}	virtual junction temperature		-40		175	°C
Weight				8.5		g
M_D	mounting torque		0.8		1.2	Nm
F_C	mounting force with clip		20		120	N
$d_{Spp/App}$	creepage distance on surface striking distance through air	terminal to terminal	6.7	5.4		mm
$d_{Spb/Appb}$		terminal to backside	10.0	8.0		mm
V_{ISOL}	isolation voltage	t = 1 second t = 1 minute	50/60 Hz, RMS; $I_{ISOL} \leq 1$ mA	2500		V
				2080		V
R_{thJA}	thermal resistance junction to ambient			50		K/W

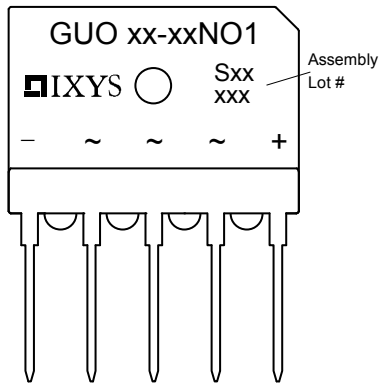

Ordering	Part Number	Marking on Product	Delivery Mode	Quantity	Code No.
Standard	GUO40-12NO1	GUO40-12NO1	Tube	15	504430

Similar Part	Package	Voltage class
GUO40-16NO1	GUPP	1600
GUO40-08NO1	GUPP	800

Equivalent Circuits for Simulation

* on die level

$T_{vj} = 175^\circ\text{C}$

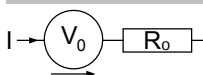

Rectifier

$V_{0\max}$	threshold voltage	0.74	V
$R_{0\max}$	slope resistance *	13.7	mΩ

Outlines GUPF

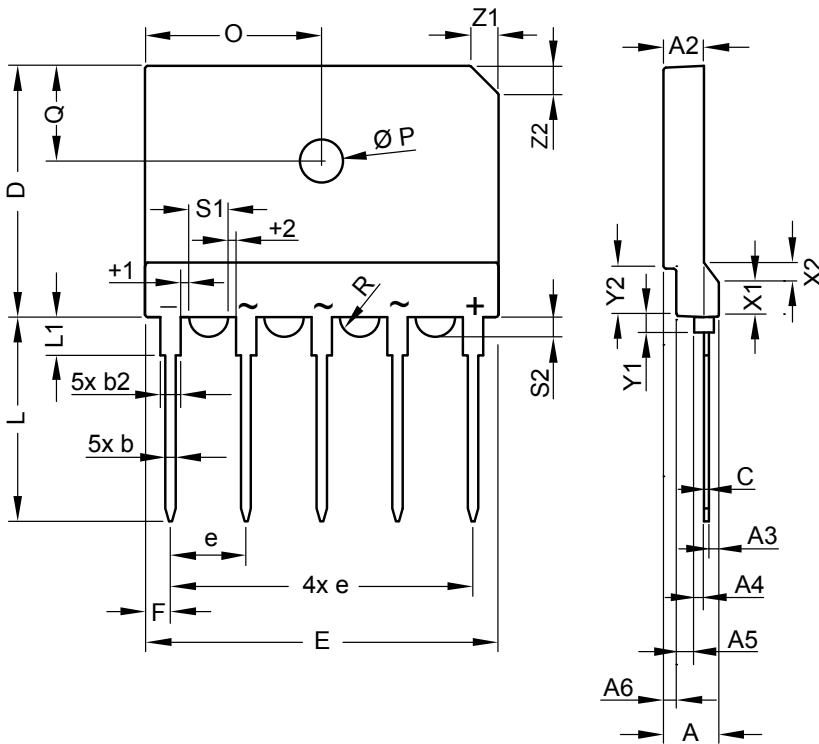

Dim.	Millimeter			Inches		
	min	typ.	max	min	typ.	max
A	5.40	5.50	5.60	0.213	0.217	0.221
A2	3.90	4.00	4.10	0.154	0.158	0.162
A3	0.95	1.00	1.10	0.037	0.039	0.043
A4	0.95	1.00	1.05	0.037	0.039	0.041
A5	1.60	1.70	1.80	0.063	0.067	0.071
A6	1.25	1.30	1.35	0.049	0.051	0.053
b	0.95	1.00	1.05	0.037	0.039	0.041
b2	1.95	2.00	2.05	0.077	0.079	0.081
C	0.45	0.50	0.55	0.018	0.020	0.022
D	24.80	25.00	25.20	0.977	0.985	0.993
E	34.70	35.00	35.30	1.367	1.379	1.391
e	BSC 7.50			BSC 0.296		
F	2.40	2.50	2.60	0.095	0.099	0.102
L	20.30	20.40	20.50	0.800	0.804	0.808
L1	3.70	3.75	3.80	0.146	0.148	0.150
O	17.40	17.50	17.60	0.686	0.690	0.693
$\varnothing P$	4.10	4.20	4.30	0.162	0.165	0.169
Q	9.20	9.30	9.40	0.362	0.366	0.370
$\varnothing/2 R$		1.77			0.070	
s1	3.45	3.50	3.55	0.136	0.138	0.140
s2	1.45	1.50	1.55	0.057	0.059	0.061
t1	0.95	1.00	1.05	0.037	0.039	0.041
t2	0.95	1.00	1.05	0.037	0.039	0.041
x1	3.20	3.30	3.40	0.126	0.130	0.134
x2	1.90	2.00	2.10	0.075	0.079	0.083
y1	1.60	1.65	1.70	0.063	0.065	0.067
y2	4.65	4.70	4.75	0.183	0.185	0.187
z1	2.80	2.90	3.00	0.110	0.114	0.118

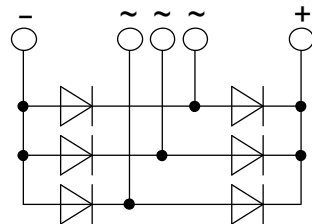

Rectifier

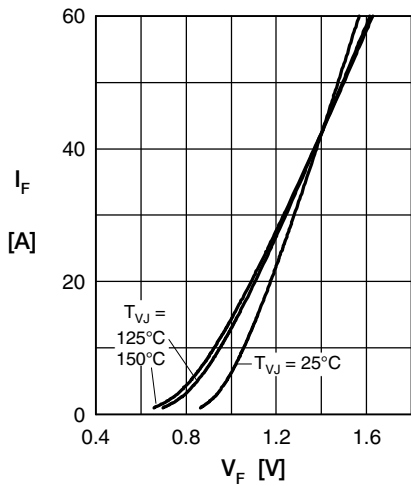

Fig. 1 Forward current vs. voltage drop per diode

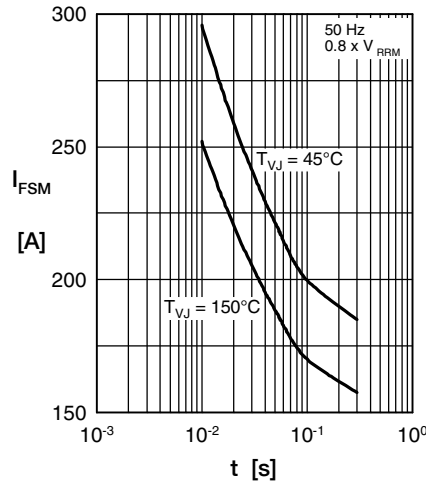

Fig. 2 Surge overload current vs. time per diode

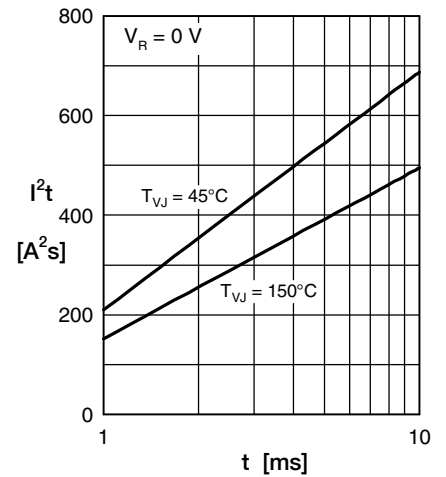

Fig. 3 I^2t vs. time per diode

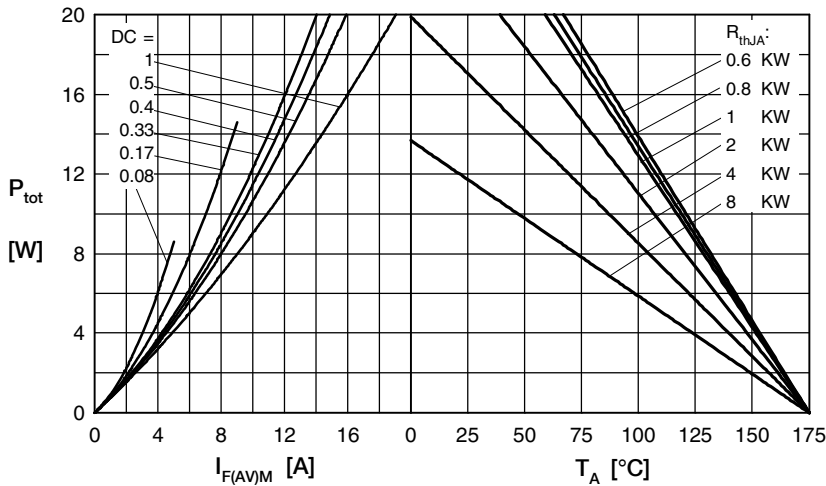

Fig. 4 Power dissipation vs. forward current and ambient temperature per diode

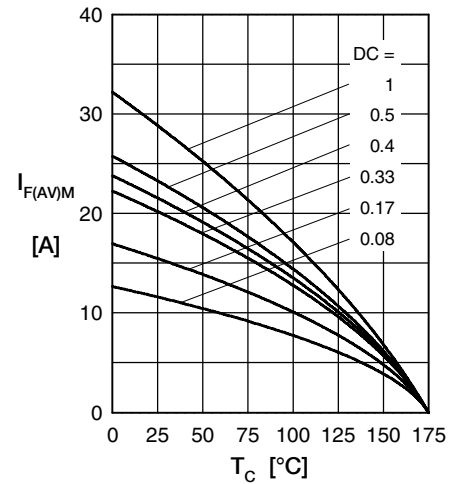

Fig. 5 Max. forward current vs. case temperature per diode

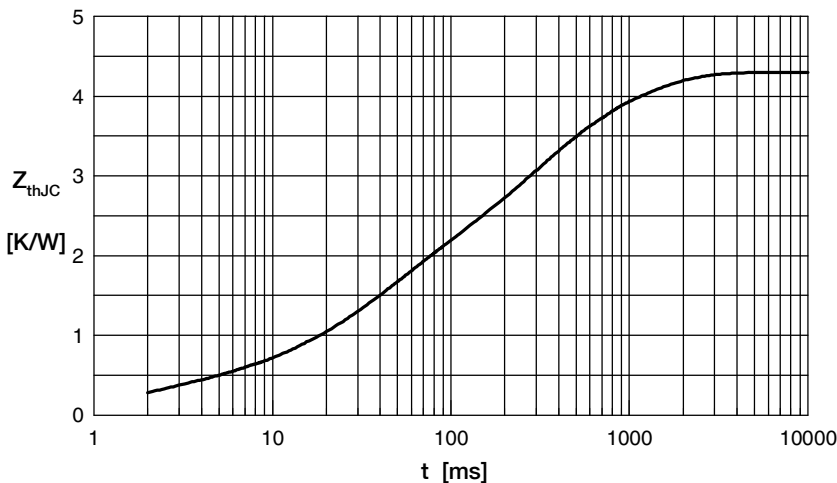

Fig. 6 Transient thermal impedance junction to case vs. time per diode

Constants for Z_{thJC} calculation:

i	R_{th} (K/W)	t_i (s)
1	0.302	0.002
2	1.252	0.032
3	1.582	0.227
4	1.164	0.820