

DS92LV010A

Bus LVDS 3.3/5.0V Single Transceiver

General Description

The DS92LV010A is one in a series of transceivers designed specifically for the high speed, low power proprietary bus backplane interfaces. The device operates from a single 3.3V or 5.0V power supply and includes one differential line driver and one receiver. To minimize bus loading the driver outputs and receiver inputs are internally connected. The logic interface provides maximum flexibility as 4 separate lines are provided (D_{IN}, DE, \overline{RE} , and R_{OUT}). The device also features flow through which allows easy PCB routing for short stubs between the bus pins and the connector. The driver has 10 mA drive capability, allowing it to drive heavily loaded backplanes, with impedance as low as 27 Ohms.

The driver translates between TTL levels (single-ended) to Low Voltage Differential Signaling levels. This allows for high speed operation, while consuming minimal power with reduced EMI. In addition the differential signaling provides common mode noise rejection of $\pm 1V$.

The receiver threshold is $\pm 100mV$ over a $\pm 1V$ common mode range and translates the low voltage differential levels to standard (CMOS/TTL) levels.

Features

- Bus LVDS Signaling (BLVDS)
- Designed for Double Termination Applications
- Balanced Output Impedance
- Lite Bus Loading 5pF typical
- Glitch free power up/down (Driver disabled)
- 3.3V or 5.0V Operation
- $\pm 1V$ Common Mode Range
- $\pm 100mV$ Receiver Sensitivity
- High Signaling Rate Capability (above 100 Mbps)
- Low Power CMOS design
- Product offered in 8 lead SOIC package
- Industrial Temperature Range Operation

Connection Diagram

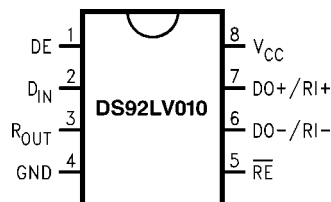

Order Number ¹⁰⁰⁰⁵²⁰¹ DS92LV010ATM
See NS Package Number M08A

Block Diagram

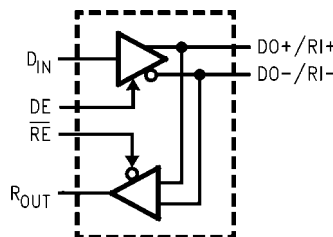

10005202

Absolute Maximum Ratings (Notes 1, 2)

If Military/Aerospace specified devices are required, please contact the National Semiconductor Sales Office/Distributors for availability and specifications.

Supply Voltage (V_{CC})	6.0V
Enable Input Voltage (DE, RE)	-0.3V to ($V_{CC} + 0.3V$)
Driver Input Voltage (DIN)	-0.3V to ($V_{CC} + 0.3V$)
Receiver Output Voltage (R_{OUT})	-0.3V to ($V_{CC} + 0.3V$)
Bus Pin Voltage (DO/RI±)	-0.3V to +3.9V
Driver Short Circuit Current	Continuous
ESD (HBM 1.5 kΩ, 100 pF)	>2.0 kV
Maximum Package Power Dissipation at 25°C	
SOIC	1025 mW

Derate SOIC Package	8.2 mW/°C
Junction Temperature	+150°C
Storage Temperature Range	-65°C to +150°C
Lead Temperature (Soldering, 4 sec.)	260°C

Recommended Operating Conditions

	Min	Max	Units
Supply Voltage (V_{CC}), or	3.0	3.6	V
Supply Voltage (V_{CC})	4.5	5.5	V
Receiver Input Voltage	0.0	2.9	V
Operating Free Air Temperature	-40	+85	°C

3.3V DC Electrical Characteristics (Notes 2, 3)

$T_A = -40^\circ\text{C}$ to $+85^\circ\text{C}$ unless otherwise noted, $V_{CC} = 3.3V \pm 0.3V$

Symbol	Parameter	Conditions	Pin	Min	Typ	Max	Units	
V_{OD}	Output Differential Voltage	$R_L = 27\Omega$, Figure 1	DO+/RI+, DO-/RI-	140	250	360	mV	
ΔV_{OD}	V_{OD} Magnitude Change				3	30	mV	
V_{OS}	Offset Voltage			1	1.25	1.65	V	
ΔV_{OS}	Offset Magnitude Change				5	50	mV	
I_{OSD}	Output Short Circuit Current	$V_O = 0V$, $DE = V_{CC}$			-12	-20	mA	
V_{OH}	Voltage Output High	$V_{ID} = +100$ mV	R_{OUT}				V	
		Inputs Open						$I_{OH} = -400$ μA
		Inputs Shorted						
		Inputs Terminated, $R_L = 27\Omega$						
V_{OL}	Voltage Output Low	$I_{OL} = 2.0$ mA, $V_{ID} = -100$ mV			0.1	0.4	V	
I_{OS}	Output Short Circuit Current	$V_{OUT} = 0V$, $V_{ID} = +100$ mV		-5	-35	-85	mA	
V_{TH}	Input Threshold High	$DE = 0V$	DO+/RI+, DO-/RI-			+100	mV	
V_{TL}	Input Threshold Low			-100			mV	
I_{IN}	Input Current	$DE = 0V$, $V_{IN} = +2.4V$, or $0V$		-20	± 1	+20	μA	
		$V_{CC} = 0V$, $V_{IN} = +2.4V$, or $0V$		-20	± 1	+20	μA	
V_{IH}	Minimum Input High Voltage		DIN, DE, RE	2.0		V_{CC}	V	
V_{IL}	Maximum Input Low Voltage			GND		0.8	V	
I_{IH}	Input High Current	$V_{IN} = V_{CC}$ or 2.4V			± 1	± 10	μA	
I_{IL}	Input Low Current	$V_{IN} = \text{GND}$ or 0.4V			± 1	± 10	μA	
V_{CL}	Input Diode Clamp Voltage	$I_{CLAMP} = -18$ mA		-1.5	-0.8		V	
I_{CCD}	Power Supply Current	$DE = \overline{RE} = V_{CC}$, $R_L = 27\Omega$	V_{CC}		13	20	mA	
I_{CCR}		$DE = \overline{RE} = 0V$			5	8	mA	
I_{CCZ}		$DE = 0V$, $\overline{RE} = V_{CC}$			3	7.5	mA	
I_{CC}		$DE = V_{CC}$, $\overline{RE} = 0V$, $R_L = 27\Omega$			16	22	mA	
C_{output}	Capacitance @ BUS Pins		DO+/RI+, DO-/RI-		5		pF	

5V DC Electrical Characteristics (Notes 2, 3)

$T_A = -40^\circ\text{C}$ to $+85^\circ\text{C}$ unless otherwise noted, $V_{CC} = 5.0\text{V} \pm 0.5\text{V}$

Symbol	Parameter	Conditions	Pin	Min	Typ	Max	Units
V_{OD}	Output Differential Voltage	$R_L = 27\Omega$, Figure 1	DO+/RI+, DO-/RI-	145	270	390	mV
ΔV_{OD}	V_{OD} Magnitude Change				3	30	mV
V_{OS}	Offset Voltage			1	1.35	1.65	V
ΔV_{OS}	Offset Magnitude Change				5	50	mV
I_{OSD}	Output Short Circuit Current			$V_O = 0\text{V}$, $DE = V_{CC}$		-12	-20
V_{OH}	Voltage Output High	$V_{ID} = +100\text{ mV}$	$I_{OH} = -400\ \mu\text{A}$	R_{OUT}	4.3	5.0	V
		Inputs Open			4.3	5.0	V
		Inputs Shorted			4.3	5.0	V
		Inputs Terminated, $R_L = 27\Omega$			4.3	5.0	V
V_{OL}	Voltage Output Low	$I_{OL} = 2.0\text{ mA}$, $V_{ID} = -100\text{ mV}$		0.1	0.4	V	
I_{OS}	Output Short Circuit Current	$V_{OUT} = 0\text{V}$, $V_{ID} = +100\text{ mV}$		-35	-90	-130	mA
V_{TH}	Input Threshold High	$DE = 0\text{V}$	DO+/RI+, DO-/RI-			+100	mV
V_{TL}	Input Threshold Low			-100			mV
I_{IN}	Input Current	$DE = 0\text{V}$, $V_{IN} = +2.4\text{V}$, or 0V		-20	± 1	+20	μA
		$V_{CC} = 0\text{V}$, $V_{IN} = +2.4\text{V}$, or 0V		-20	± 1	+20	μA
V_{IH}	Minimum Input High Voltage		DIN, DE, RE	2.0		V_{CC}	V
V_{IL}	Maximum Input Low Voltage			GND		0.8	V
I_{IH}	Input High Current	$V_{IN} = V_{CC}$ or 2.4V			± 1	± 10	μA
I_{IL}	Input Low Current	$V_{IN} = \text{GND}$ or 0.4V			± 1	± 10	μA
V_{CL}	Input Diode Clamp Voltage	$I_{CLAMP} = -18\text{ mA}$		-1.5	-0.8		V
I_{CCD}	Power Supply Current	$DE = \overline{RE} = V_{CC}$, $R_L = 27\Omega$	V_{CC}		17	25	mA
I_{CCR}		$DE = \overline{RE} = 0\text{V}$			6	10	mA
I_{CCZ}		$DE = 0\text{V}$, $\overline{RE} = V_{CC}$			3	8	mA
I_{CC}		$DE = V_{CC}$, $\overline{RE} = 0\text{V}$, $R_L = 27\Omega$			20	25	mA
C_{output}	Capacitance @ BUS Pins		DO+/RI+, DO-/RI-		5		pF

Note 1: "Absolute Maximum Ratings" are these beyond which the safety of the device cannot be guaranteed. They are not meant to imply that the device should be operated at these limits. The table of "Electrical Characteristics" provides conditions for actual device operation.

Note 2: All currents into device pins are positive; all currents out of device pins are negative. All voltages are referenced to device ground except V_{OD} , V_{ID} , V_{TH} and V_{TL} unless otherwise specified.

Note 3: All typicals are given for $V_{CC} = +3.3\text{V}$ or 5.0V and $T_A = +25^\circ\text{C}$, unless otherwise stated.

Note 4: ESD Rating: HBM (1.5 k Ω , 100 pF) > 2.0 kV EAT (0 Ω , 200 pF) > 300V.

Note 5: C_L includes probe and fixture capacitance.

Note 6: Generator waveforms for all tests unless otherwise specified: $f = 1\text{MHz}$, $Z_O = 50\Omega$, t_r , $t_f \leq 6.0\text{ns}$ (0%–100%) on control pins and $\leq 1.0\text{ns}$ for RI inputs.

Note 7: The DS92LV010A is a current mode device and only function with datasheet specification when a resistive load is applied between the driver outputs.

Note 8: For receiver TRI-STATE[®] delays, the switch is set to V_{CC} for t_{PZL} and t_{PLZ} and to GND for t_{PZH} and t_{PHZ} .

3.3V AC Electrical Characteristics (Note 6)

$T_A = -40^\circ\text{C}$ to $+85^\circ\text{C}$, $V_{CC} = 3.3\text{V} \pm 0.3\text{V}$

Symbol	Parameter	Conditions	Min	Typ	Max	Units	
DIFFERENTIAL DRIVER TIMING REQUIREMENTS							
t_{PHLD}	Differential Prop. Delay High to Low	$R_L = 27\Omega$, Figures 2, 3 $C_L = 10\text{ pF}$	1.0	3.0	5.0	ns	
t_{PLHD}	Differential Prop. Delay Low to High		1.0	2.8	5.0	ns	
t_{SKD}	Differential SKEW $ t_{PHLD} - t_{PLHD} $			0.2	1.0	ns	
t_{TLH}	Transition Time Low to High				0.3	2.0	ns
t_{THL}	Transition Time High to Low				0.3	2.0	ns

Symbol	Parameter	Conditions	Min	Typ	Max	Units	
t_{PHZ}	Disable Time High to Z	$R_L = 27\Omega$, Figures 4, 5 $C_L = 10$ pF	0.5	4.5	9.0	ns	
t_{PLZ}	Disable Time Low to Z		0.5	5.0	10.0	ns	
t_{PZH}	Enable Time Z to High		2.0	5.0	7.0	ns	
t_{PZL}	Enable Time Z to Low		1.0	4.5	9.0	ns	
DIFFERENTIAL RECEIVER TIMING REQUIREMENTS							
t_{PHLD}	Differential Prop. Delay High to Low	Figures 6, 7 $C_L = 10$ pF	2.5	5.0	12.0	ns	
t_{PLHD}	Differential Prop. Delay Low to High		2.5	5.5	10.0	ns	
t_{SKD}	Differential SKEW $ t_{PHLD} - t_{PLHD} $			0.5	2.0	ns	
t_r	Rise Time				1.5	4.0	ns
t_f	Fall Time				1.5	4.0	ns
t_{PHZ}	Disable Time High to Z	$R_L = 500\Omega$, Figures 8, 9 $C_L = 10$ pF (Note 8)	2.0	4.0	6.0	ns	
t_{PLZ}	Disable Time Low to Z		2.0	5.0	7.0	ns	
t_{PZH}	Enable Time Z to High		2.0	7.0	13.0	ns	
t_{PZL}	Enable Time Z to Low		2.0	6.0	10.0	ns	

5V AC Electrical Characteristics (Note 6)

$T_A = -40^\circ\text{C}$ to $+85^\circ\text{C}$, $V_{CC} = 5.0\text{V} \pm 0.5\text{V}$

Symbol	Parameter	Conditions	Min	Typ	Max	Units	
DIFFERENTIAL DRIVER TIMING REQUIREMENTS							
t_{PHLD}	Differential Prop. Delay High to Low	$R_L = 27\Omega$, Figures 2, 3 $C_L = 10$ pF	0.5	2.7	4.5	ns	
t_{PLHD}	Differential Prop. Delay Low to High		0.5	2.5	4.5	ns	
t_{SKD}	Differential SKEW $ t_{PHLD} - t_{PLHD} $				0.2	1.0	ns
t_{TLH}	Transition Time Low to High				0.3	2.0	ns
t_{THL}	Transition Time High to Low				0.3	2.0	ns
t_{PHZ}	Disable Time High to Z	$R_L = 27\Omega$, Figures 4, 5 $C_L = 10$ pF	0.5	3.0	7.0	ns	
t_{PLZ}	Disable Time Low to Z		0.5	5.0	10.0	ns	
t_{PZH}	Enable Time Z to High		2.0	4.0	7.0	ns	
t_{PZL}	Enable Time Z to Low		1.0	4.0	9.0	ns	
DIFFERENTIAL RECEIVER TIMING REQUIREMENTS							
t_{PHLD}	Differential Prop. Delay High to Low	Figures 6, 7 $C_L = 10$ pF	2.5	5.0	12.0	ns	
t_{PLHD}	Differential Prop. Delay Low to High		2.5	4.6	10.0	ns	
t_{SKD}	Differential SKEW $ t_{PHLD} - t_{PLHD} $				0.4	2.0	ns
t_r	Rise Time				1.2	2.5	ns
t_f	Fall Time				1.2	2.5	ns
t_{PHZ}	Disable Time High to Z	$R_L = 500\Omega$, Figures 8, 9 $C_L = 10$ pF (Note 8)	2.0	4.0	6.0	ns	
t_{PLZ}	Disable Time Low to Z		2.0	4.0	6.0	ns	
t_{PZH}	Enable Time Z to High		2.0	5.0	9.0	ns	
t_{PZL}	Enable Time Z to Low		2.0	5.0	7.0	ns	

Test Circuits and Timing Waveforms

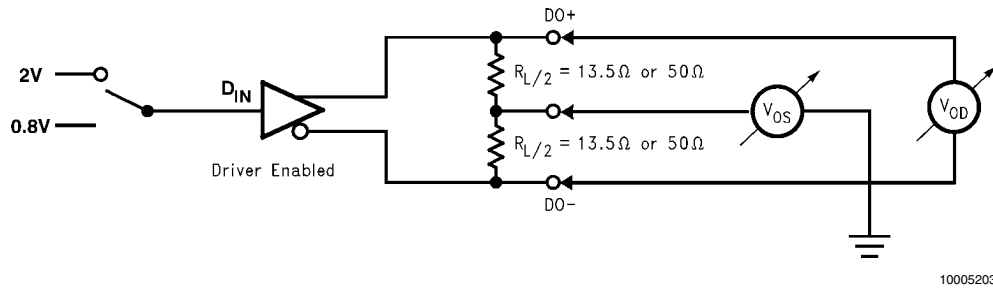

FIGURE 1. Differential Driver DC Test Circuit

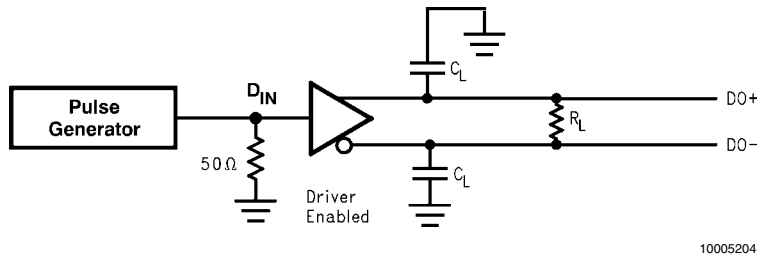

FIGURE 2. Differential Driver Propagation Delay and Transition Time Test Circuit

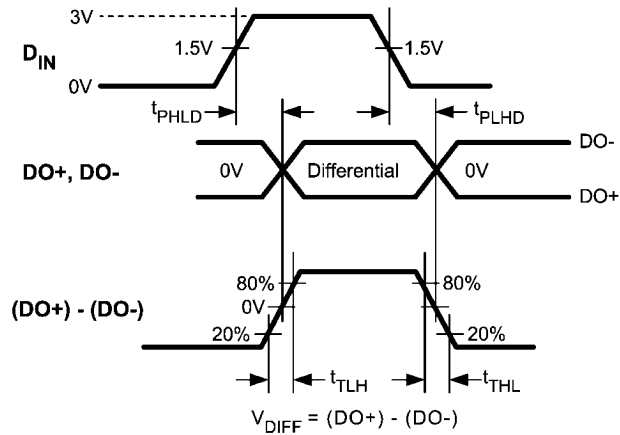
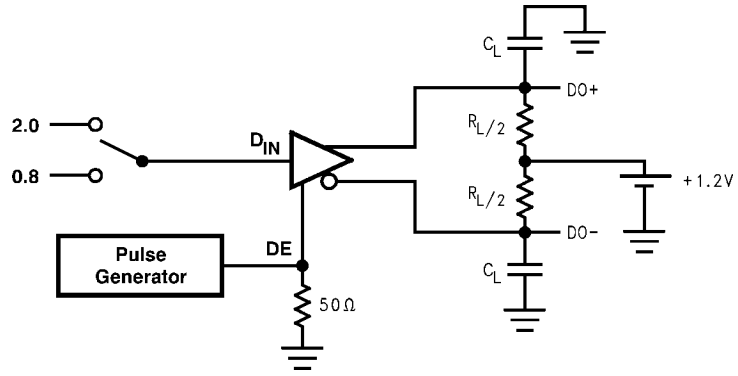
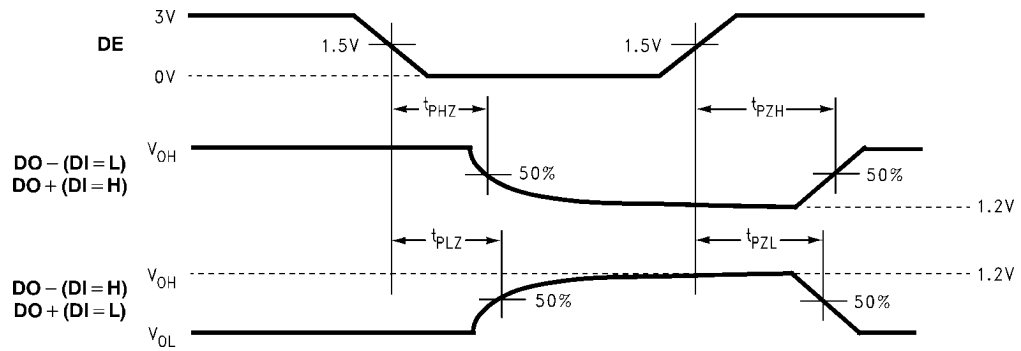

FIGURE 3. Differential Driver Propagation Delay and Transition Time Waveforms



10005206

FIGURE 4. Driver TRI-STATE Delay Test Circuit



10005207

FIGURE 5. Driver TRI-STATE Delay Waveforms

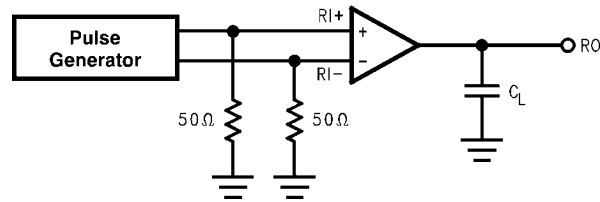

10005208

FIGURE 6. Receiver Propagation Delay and Transition Time Test Circuit

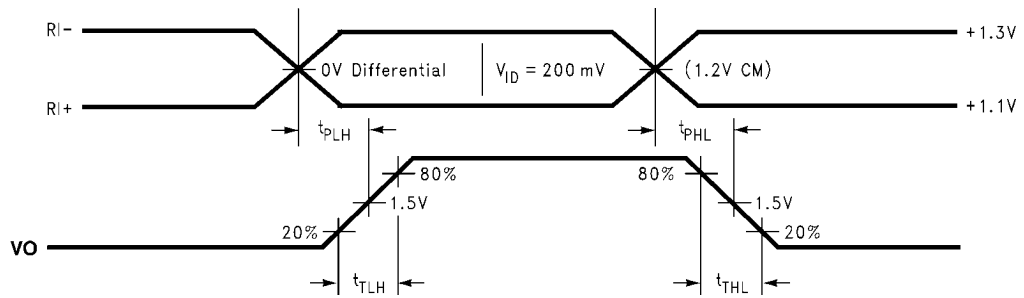

10005209

FIGURE 7. Receiver Propagation Delay and Transition Time Waveforms

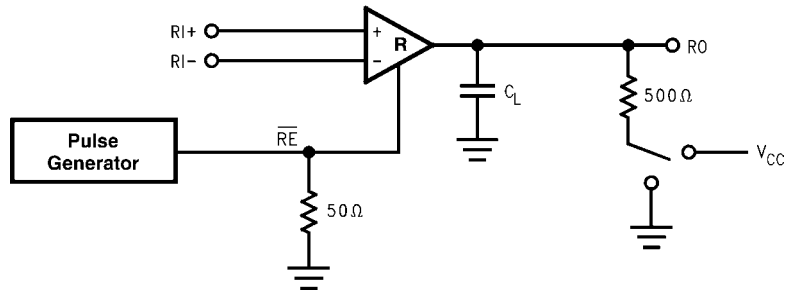

10005210

FIGURE 8. Receiver TRI-STATE Delay Test Circuit

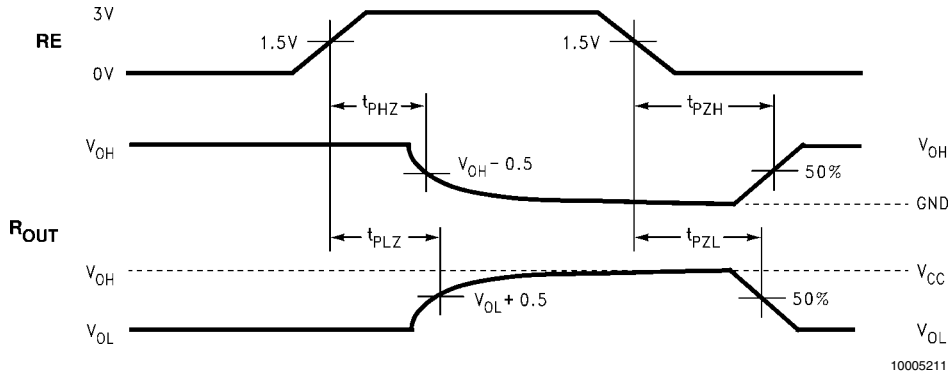

10005211

FIGURE 9. Receiver TRI-STATE Delay Waveforms

Typical Bus Application Configurations

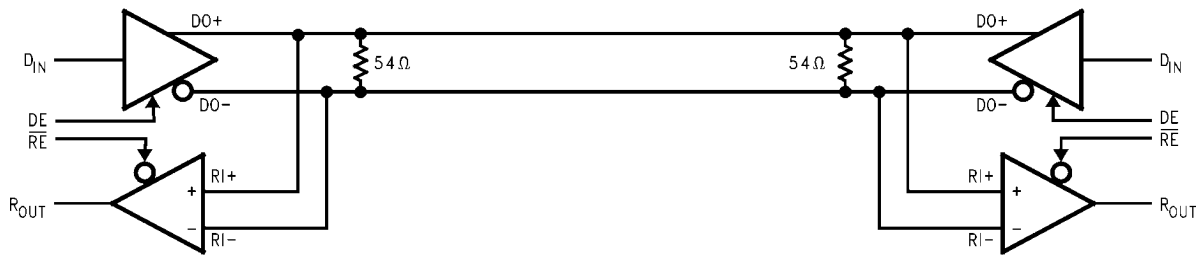

10005212

Bi-Directional Half-Duplex Point-to-Point Applications

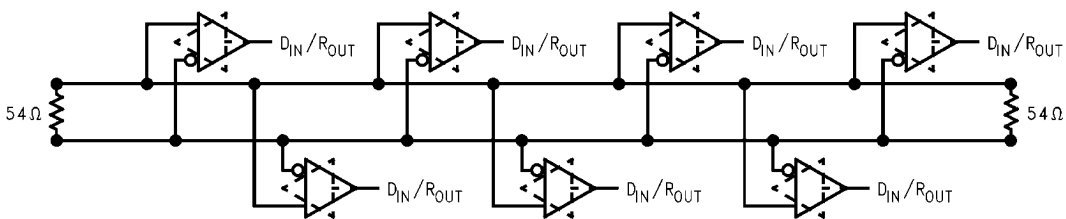

10005213

Multi-Point Bus Applications

Application Information

There are a few common practices which should be implied when designing PCB for BLVDS signaling. Recommended practices are:

- Use at least 4 layer PCB board (BLVDS signals, ground, power and TTL signals).
- Keep drivers and receivers as close to the (BLVDS port side) connector as possible.
- Bypass each BLVDS device and also use distributed bulk capacitance. Surface mount capacitors placed close to power and ground pins work best. Two or three multi-layer ceramic (MLC) surface mount capacitors (0.1 μ F, and 0.01 μ F in parallel should be used between each V_{CC} and ground. The capacitors should be as close as possible to the V_{CC} pin.
- Use the termination resistor which best matches the differential impedance of your transmission line.
- Leave unused LVDS receiver inputs open (floating)

TABLE 1. Functional Table

MODE SELECTED	DE	\overline{RE}
DRIVER MODE	H	H
RECEIVER MODE	L	L
TRI-STATE MODE	L	H
LOOP BACK MODE	H	L

TABLE 4. Device Pin Descriptions

Pin Name	Pin #	Input/Output	Description
DIN	2	I	TTL Driver Input
DO_{\pm}/RI_{\pm}	6, 7	I/O	LVDS Driver Outputs/LVDS Receiver Inputs
R_{OUT}	3	O	TTL Receiver Output
\overline{RE}	5	I	Receiver Enable TTL Input (Active Low)
DE	1	I	Driver Enable TTL Input (Active High)
GND	4	NA	Ground
V_{CC}	8	NA	Power Supply

TABLE 2. Transmitter Mode

INPUTS		OUTPUTS	
DE	DI	DO+	DO-
H	L	L	H
H	H	H	L
H	$2 > \& > 0.8$	X	X
L	X	Z	Z

L = Low state
H = High state

TABLE 3. Receiver Mode

INPUTS		OUTPUT
\overline{RE}	(RI+)-(RI-)	
L	L (< -100 mV)	L
L	H (> +100 mV)	H
L	100 mV > & > -100 mV	X
H	X	Z

X = High or Low logic state
Z = High impedance state
L = Low state
H = High state

Physical Dimensions inches (millimeters) unless otherwise noted

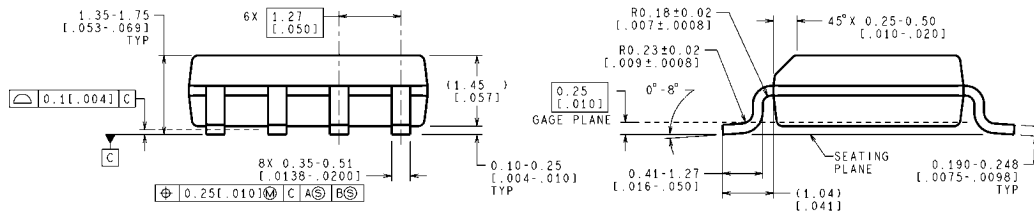
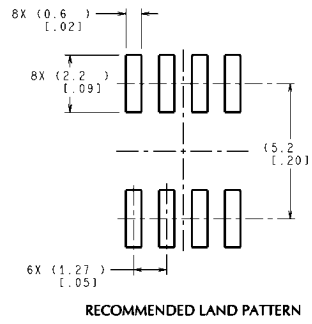
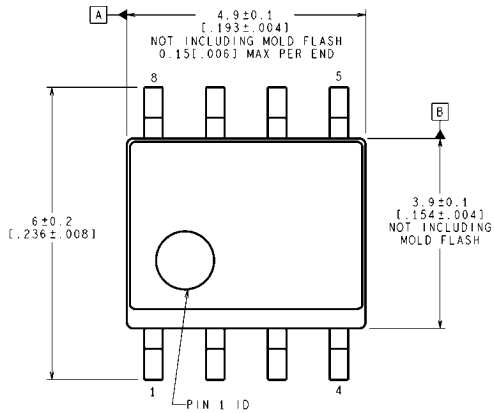

CONTROLLING DIMENSION IS MILLIMETER
VALUES IN [] ARE INCHES
DIMENSIONS IN () FOR REFERENCE ONLY

Order Number DS92LV010ATM
See NS Package Number M08A

M08A (Rev L)

Notes

For more National Semiconductor product information and proven design tools, visit the following Web sites at:

Products		Design Support	
Amplifiers	www.national.com/amplifiers	WEBENCH	www.national.com/webench
Audio	www.national.com/audio	Analog University	www.national.com/AU
Clock Conditioners	www.national.com/timing	App Notes	www.national.com/appnotes
Data Converters	www.national.com/adc	Distributors	www.national.com/contacts
Displays	www.national.com/displays	Green Compliance	www.national.com/quality/green
Ethernet	www.national.com/ethernet	Packaging	www.national.com/packaging
Interface	www.national.com/interface	Quality and Reliability	www.national.com/quality
LVDS	www.national.com/lvds	Reference Designs	www.national.com/refdesigns
Power Management	www.national.com/power	Feedback	www.national.com/feedback
Switching Regulators	www.national.com/switchers		
LDOs	www.national.com/ldo		
LED Lighting	www.national.com/led		
PowerWise	www.national.com/powerwise		
Serial Digital Interface (SDI)	www.national.com/sdi		
Temperature Sensors	www.national.com/tempsensors		
Wireless (PLL/VCO)	www.national.com/wireless		

THE CONTENTS OF THIS DOCUMENT ARE PROVIDED IN CONNECTION WITH NATIONAL SEMICONDUCTOR CORPORATION ("NATIONAL") PRODUCTS. NATIONAL MAKES NO REPRESENTATIONS OR WARRANTIES WITH RESPECT TO THE ACCURACY OR COMPLETENESS OF THE CONTENTS OF THIS PUBLICATION AND RESERVES THE RIGHT TO MAKE CHANGES TO SPECIFICATIONS AND PRODUCT DESCRIPTIONS AT ANY TIME WITHOUT NOTICE. NO LICENSE, WHETHER EXPRESS, IMPLIED, ARISING BY ESTOPPEL OR OTHERWISE, TO ANY INTELLECTUAL PROPERTY RIGHTS IS GRANTED BY THIS DOCUMENT.

TESTING AND OTHER QUALITY CONTROLS ARE USED TO THE EXTENT NATIONAL DEEMS NECESSARY TO SUPPORT NATIONAL'S PRODUCT WARRANTY. EXCEPT WHERE MANDATED BY GOVERNMENT REQUIREMENTS, TESTING OF ALL PARAMETERS OF EACH PRODUCT IS NOT NECESSARILY PERFORMED. NATIONAL ASSUMES NO LIABILITY FOR APPLICATIONS ASSISTANCE OR BUYER PRODUCT DESIGN. BUYERS ARE RESPONSIBLE FOR THEIR PRODUCTS AND APPLICATIONS USING NATIONAL COMPONENTS. PRIOR TO USING OR DISTRIBUTING ANY PRODUCTS THAT INCLUDE NATIONAL COMPONENTS, BUYERS SHOULD PROVIDE ADEQUATE DESIGN, TESTING AND OPERATING SAFEGUARDS.

EXCEPT AS PROVIDED IN NATIONAL'S TERMS AND CONDITIONS OF SALE FOR SUCH PRODUCTS, NATIONAL ASSUMES NO LIABILITY WHATSOEVER, AND NATIONAL DISCLAIMS ANY EXPRESS OR IMPLIED WARRANTY RELATING TO THE SALE AND/OR USE OF NATIONAL PRODUCTS INCLUDING LIABILITY OR WARRANTIES RELATING TO FITNESS FOR A PARTICULAR PURPOSE, MERCHANTABILITY, OR INFRINGEMENT OF ANY PATENT, COPYRIGHT OR OTHER INTELLECTUAL PROPERTY RIGHT.

LIFE SUPPORT POLICY

NATIONAL'S PRODUCTS ARE NOT AUTHORIZED FOR USE AS CRITICAL COMPONENTS IN LIFE SUPPORT DEVICES OR SYSTEMS WITHOUT THE EXPRESS PRIOR WRITTEN APPROVAL OF THE CHIEF EXECUTIVE OFFICER AND GENERAL COUNSEL OF NATIONAL SEMICONDUCTOR CORPORATION. As used herein:

Life support devices or systems are devices which (a) are intended for surgical implant into the body, or (b) support or sustain life and whose failure to perform when properly used in accordance with instructions for use provided in the labeling can be reasonably expected to result in a significant injury to the user. A critical component is any component in a life support device or system whose failure to perform can be reasonably expected to cause the failure of the life support device or system or to affect its safety or effectiveness.

National Semiconductor and the National Semiconductor logo are registered trademarks of National Semiconductor Corporation. All other brand or product names may be trademarks or registered trademarks of their respective holders.

Copyright© 2007 National Semiconductor Corporation

For the most current product information visit us at www.national.com



**National Semiconductor
Americas Customer
Support Center**
Email:
new.feedback@nsc.com
Tel: 1-800-272-9959

**National Semiconductor Europe
Customer Support Center**
Fax: +49 (0) 180-530-85-86
Email: europe.support@nsc.com
Deutsch Tel: +49 (0) 69 9508 6208
English Tel: +49 (0) 870 24 0 2171
Français Tel: +33 (0) 1 41 91 8790

**National Semiconductor Asia
Pacific Customer Support Center**
Email: ap.support@nsc.com

**National Semiconductor Japan
Customer Support Center**
Fax: 81-3-5639-7507
Email: jpn.feedback@nsc.com
Tel: 81-3-5639-7560