

LM2936-5.0

Ultra-Low Quiescent Current 5V Regulator

General Description

The LM2936 ultra-low quiescent current regulator features low dropout voltage and low current in the standby mode. With less than 15 μA quiescent current at a 100 μA load, the LM2936 is ideally suited for automotive and other battery operated systems. The LM2936 retains all of the features that are common to low dropout regulators including a low dropout PNP pass device, short circuit protection, reverse battery protection, and thermal shutdown. The LM2936 has a 40V maximum operating voltage limit, a -40°C to $+125^{\circ}\text{C}$ operating temperature range, and $\pm 3\%$ output voltage tolerance over the entire output current, input voltage, and temperature range. The LM2936 is available in a TO-92 package, a SO-8 surface mount package, and a TO-252 surface mount power package.

Features

- Ultra low quiescent current ($I_Q \leq 15 \mu\text{A}$ for $I_O \leq 100 \mu\text{A}$)
- Fixed 5V, 50 mA output
- Output tolerance $\pm 3\%$ over line, load, and temperature
- Dropout voltage typically 200 mV @ $I_O = 50 \text{ mA}$
- Reverse battery protection
- -50V reverse transient protection
- Internal short circuit current limit
- Internal thermal shutdown protection
- 40V operating voltage limit

Typical Application

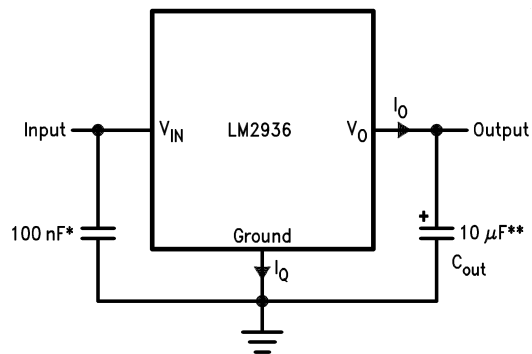

DS009759-1

* Required if regulator is located more than 2" from power supply filter capacitor.

** Required for stability. Must be rated for 10 μF minimum over intended operating temperature range. Effective series resistance (ESR) is critical, see curve. Locate capacitor as close as possible to the regulator output and ground pins. Capacitance may be increased without bound.

Connection Diagrams

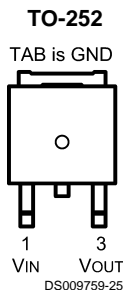

Top View
Order Number LM2936DT-5.0
See NS Package Number TD03B

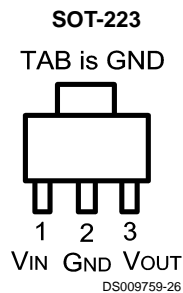

Top View
Order Number LM2936MP-5.0
See NS Package Number MA04A

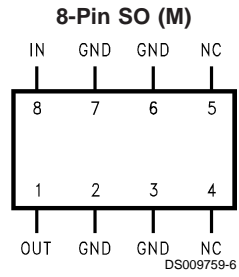
Connection Diagrams (Continued)

Top View
Order Number LM2936M-5.0
See NS Package Number M08A

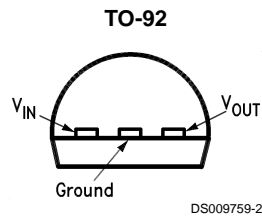

Bottom View
Order Number LM2936Z-5.0
See NS Package Number Z03A

Absolute Maximum Ratings (Note 1)

If Military/Aerospace specified devices are required, please contact the National Semiconductor Sales Office/Distributors for availability and specifications.

Input Voltage (Survival)	+60V, -50V
ESD Susceptibility (Note 2)	2000V
Power Dissipation (Note 3)	Internally limited
Junction Temperature (T_{Jmax})	150°C
Storage Temperature Range	-65°C to +150°C
Lead Temperature (Soldering, 10 sec.)	260°C

Operating Ratings

Operating Temperature Range	-40°C to +125°C
Maximum Input Voltage (Operational)	40V
TO-92 (Z03A) θ_{JA}	195°C/W
SO-8 (M08A) θ_{JA}	140°C/W
SO-8 (M08A) θ_{JC}	45°C/W
TO-252 (TD03B) θ_{JA}	136°C/W
TO-252 (TD03B) θ_{JC}	6°C/W
SOT-223 (MA04A) θ_{JA}	149°C/W
SOT-223 (MA04A) θ_{JC}	36°C/W

Electrical Characteristics

$V_{IN} = 14V$, $I_O = 10\text{ mA}$, $T_J = 25^\circ\text{C}$, unless otherwise specified. **Boldface** limits apply over entire operating temperature range

Parameter	Conditions	Typical (Note 4)	Tested Limit (Note 5)	Units
Output Voltage	$5.5V \leq V_{IN} \leq 26V$, $100\ \mu\text{A} \leq I_O \leq 50\ \text{mA}$ (Note 6)		4.85	V_{min}
			5	V
			5.15	V_{max}
Quiescent Current	$I_O = 100\ \mu\text{A}$, $8V \leq V_{IN} \leq 24V$	9	15	μA_{max}
	$I_O = 10\ \text{mA}$, $8V \leq V_{IN} \leq 24V$	0.20	0.50	mA_{max}
	$I_O = 50\ \text{mA}$, $8V \leq V_{IN} \leq 24V$	1.5	2.5	mA_{max}
Line Regulation	$9V \leq V_{IN} \leq 16V$	5	10	mV_{max}
	$6V \leq V_{IN} \leq 40V$, $I_O = 1\ \text{mA}$	10	30	
Load Regulation	$100\ \mu\text{A} \leq I_O \leq 5\ \text{mA}$	10	30	mV_{max}
	$5\ \text{mA} \leq I_O \leq 50\ \text{mA}$	10	30	
Dropout Voltage	$I_O = 100\ \mu\text{A}$	0.05	0.10	V_{max}
	$I_O = 50\ \text{mA}$	0.20	0.40	V_{max}
Short Circuit Current	$V_O = 0V$	120	65	mA_{min}
			250	mA_{max}
Output Impedance	$I_O = 30\ \text{mAdc}$ and $10\ \text{mArms}$, $f = 1000\ \text{Hz}$	450		$\text{m}\Omega$
Output Noise Voltage	10 Hz–100 kHz	500		μV_{rms}
Long Term Stability		20		$\text{mV}/1000\ \text{Hr}$
Ripple Rejection	$V_{ripple} = 1\ V_{rms}$, $f_{ripple} = 120\ \text{Hz}$	60	40	dB_{min}
Reverse Polarity DC Input Voltage	$R_L = 500\ \Omega$, $V_O \geq -0.3V$		-15	V_{min}
Reverse Polarity Transient Input Voltage	$R_L = 500\ \Omega$, $T = 1\ \text{ms}$	-80	-50	V_{min}
Output Leakage with Reverse Polarity Input	$V_{IN} = -15V$, $R_L = 500\ \Omega$	-0.1	-600	μA_{max}
Maximum Line Transient	$R_L = 500\ \Omega$, $V_O \leq 5.5V$, $T = 40\ \text{ms}$		60	V_{min}

Note 1: Absolute Maximum Ratings indicate limits beyond which damage to the device may occur. DC and AC electrical specifications do not apply when operating the device beyond its specified operating ratings.

Note 2: Human body model, 100 pF discharge through a 1.5 k Ω resistor.

Note 3: The maximum power dissipation is a function of T_{Jmax} , θ_{JA} , and T_A . The maximum allowable power dissipation at any ambient temperature is $P_D = (T_{Jmax} - T_A)/\theta_{JA}$. If this dissipation is exceeded, the die temperature will rise above 150°C and the LM2936 will go into thermal shutdown.

Note 4: Typicals are at 25°C (unless otherwise specified) and represent the most likely parametric norm.

Note 5: Tested limits are guaranteed to National's AOQL (Average Outgoing Quality Level) and 100% tested.

Note 6: To ensure constant junction temperature, pulse testing is used.

Typical Performance Characteristics

Maximum Power Dissipation (TO-92)

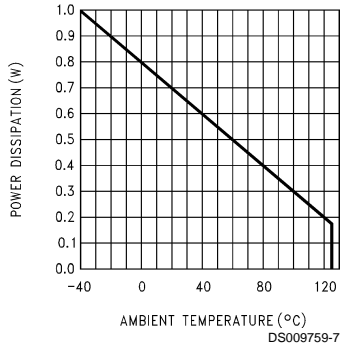

Dropout Voltage

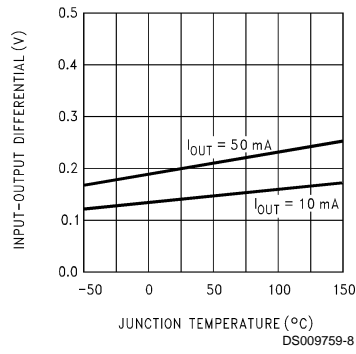

Dropout Voltage

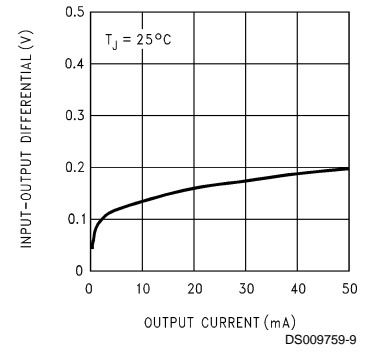

Quiescent Current

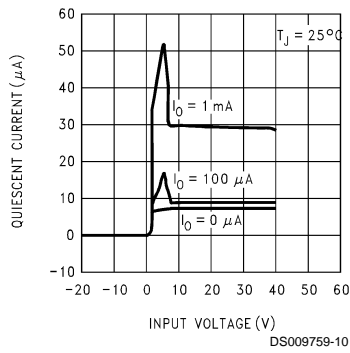

Quiescent Current

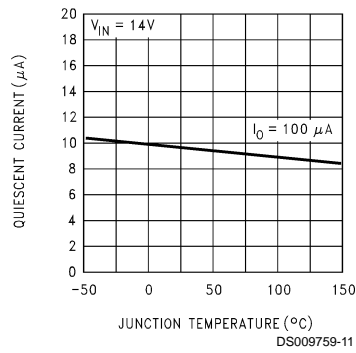

Quiescent Current

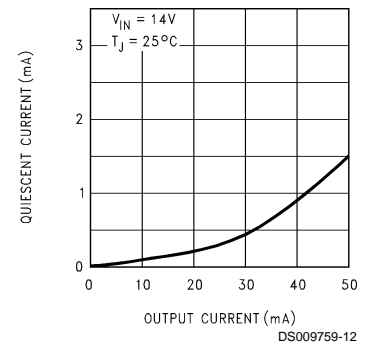

Quiescent Current

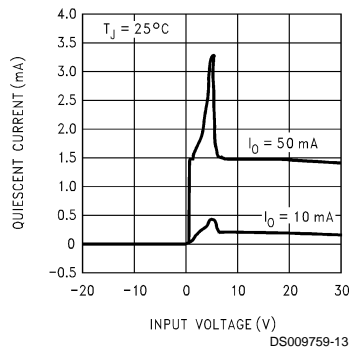

Quiescent Current

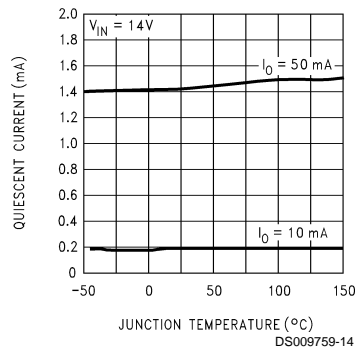

Output Capacitor ESR

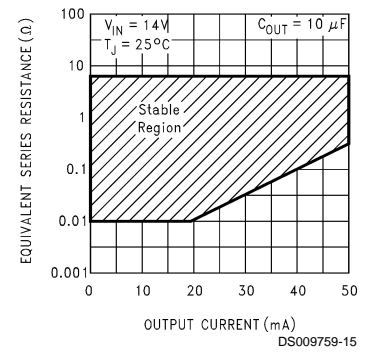

Peak Output Current

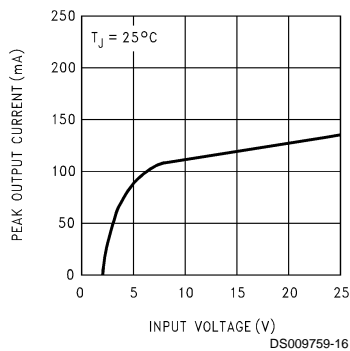

Peak Output Current

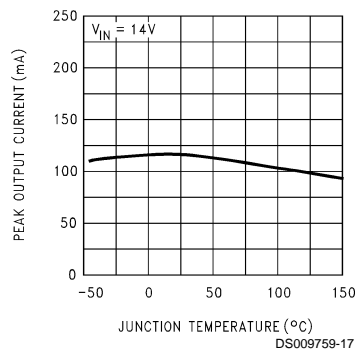

Current Limit

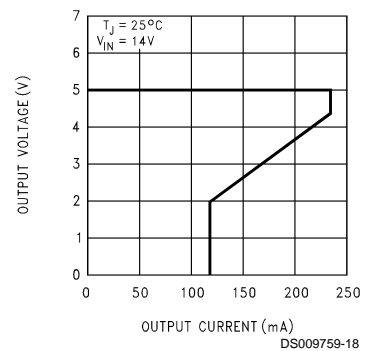

Typical Performance Characteristics (Continued)

Line Transient Response

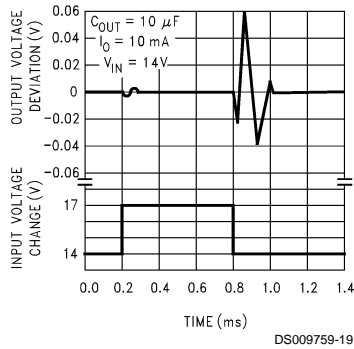

Output at Voltage Extremes

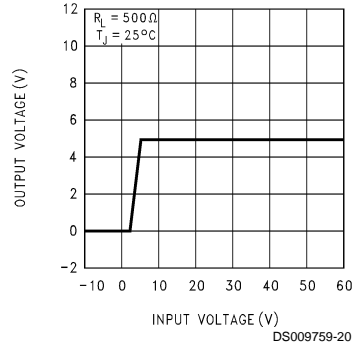

Ripple Rejection

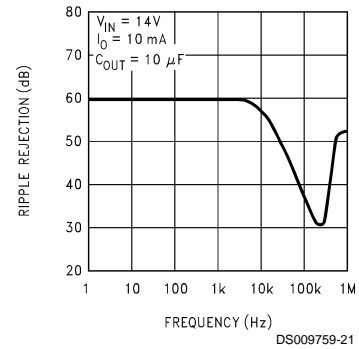

Load Transient Response

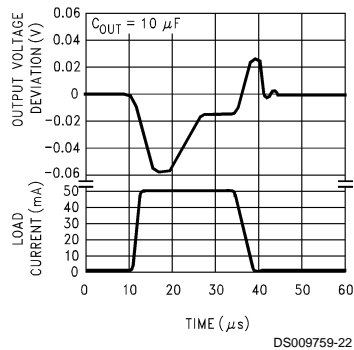

Low Voltage Behavior

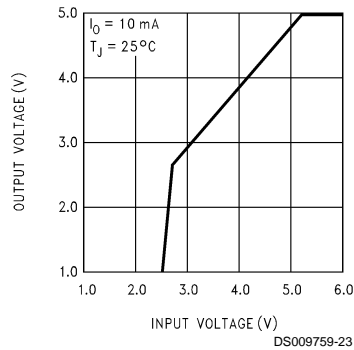

Output Impedance

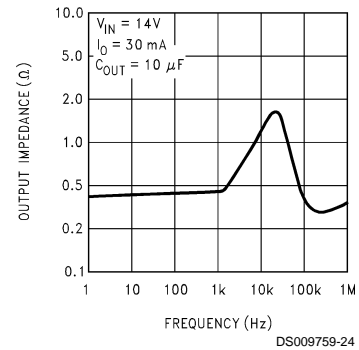

Applications Information

Unlike other PNP low dropout regulators, the LM2936 remains fully operational to 40V. Owing to power dissipation characteristics of the available packages, full output current cannot be guaranteed for all combinations of ambient temperature and input voltage. As an example, consider an LM2936Z operating at 25°C ambient. Using the formula for maximum allowable power dissipation given in (Note 3), we find that $P_{Dmax} = 641 \text{ mW}$ at 25°C. Including the small contribution of the quiescent current to total power dissipation the maximum input voltage (while still delivering 50 mA output current) is 17.3V. The LM2936Z will go into thermal shutdown if it attempts to deliver full output current with an input voltage of more than 17.3V. Similarly, at 40V input and 25°C ambient the LM2936Z can deliver 18 mA maximum.

Under conditions of higher ambient temperatures, the voltage and current calculated in the previous examples will drop. For instance, at the maximum ambient of 125°C the LM2936Z can only dissipate 128 mW, limiting the input voltage to 7.34V for a 50 mA load, or 3.5 mA output current for a 40V input.

The junction to ambient thermal resistance θ_{JA} rating has two distinct components: the junction to case thermal resistance rating θ_{JC} ; and the case to ambient thermal resistance rating θ_{CA} . The relationship is defined as: $\theta_{JA} = \theta_{JC} + \theta_{CA}$.

For the SO-8 and TO-252 surface mount packages the θ_{JA} rating can be improved by using the copper mounting pads on the printed circuit board as a thermal conductive path to extract heat from the package.

On the SO-8 package the four ground pins are thermally connected to the backside of the die. Adding approximately 0.04 square inches of 2 oz. copper pad area to these four pins will improve the θ_{JA} rating to approximately 110°C/W. If this extra pad area is placed directly beneath the package there should not be any impact on board density.

On the TO-252 package the ground tab is thermally connected to the backside of the die. Adding 1 square inch of 2 oz. copper pad area directly under the ground tab will improve the θ_{JA} rating to approximately 50°C/W.

While the LM2936 has an internally set thermal shutdown point of typically 150°C, this is intended as a safety feature only. Continuous operation near the thermal shutdown temperature should be avoided as it may have a negative effect on the life of the device.

While the LM2936 maintains regulation to 60V, it will not withstand a short circuit above 40V because of safe operating area limitations in the internal PNP pass device. Above 60V the LM2936 will break down with catastrophic effects on the regulator and possibly the load as well. Do not use this device in a design where the input operating voltage may exceed 40V, or where transients are likely to exceed 60V.

Equivalent Schematic Diagram

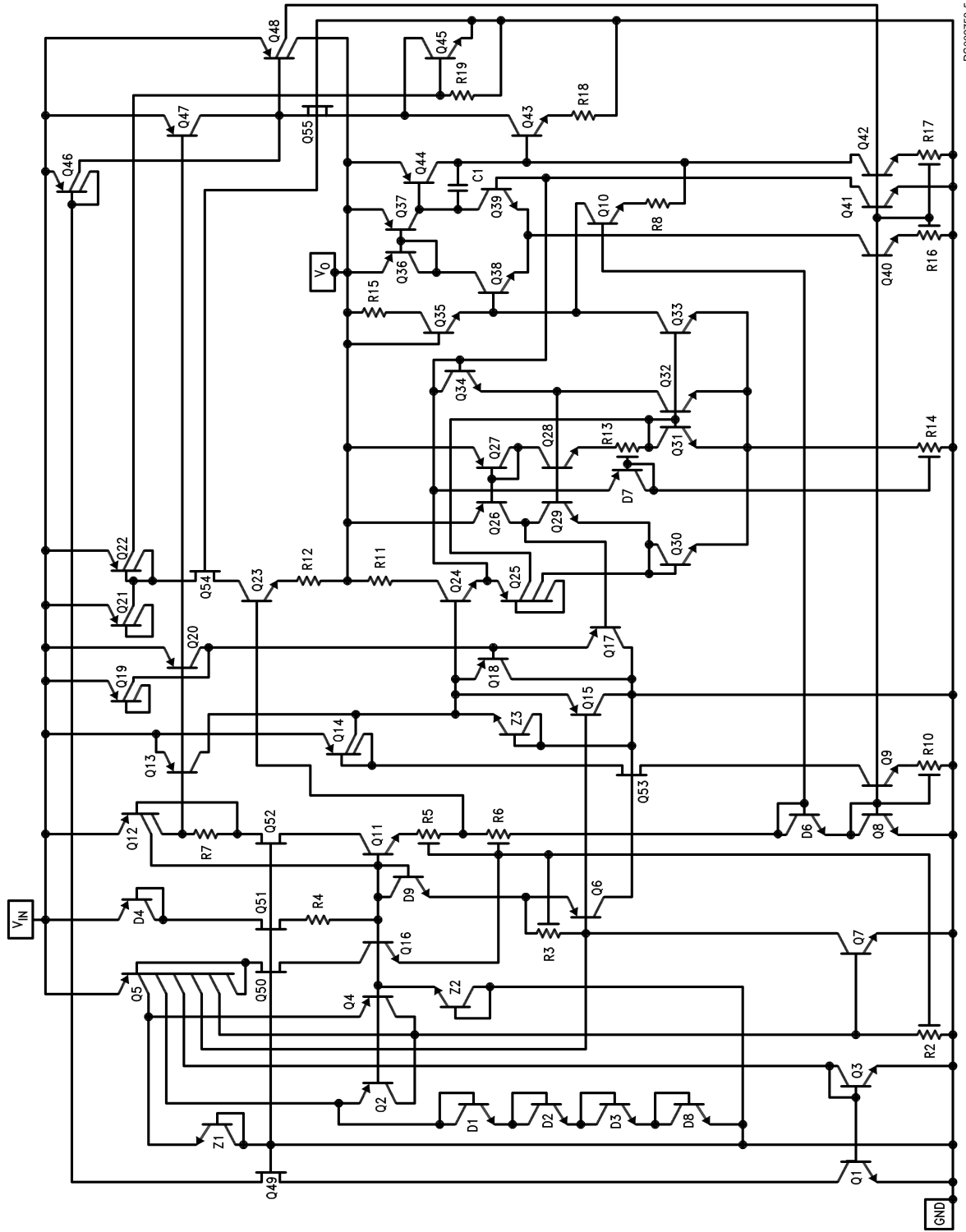

Physical Dimensions inches (millimeters) unless otherwise noted

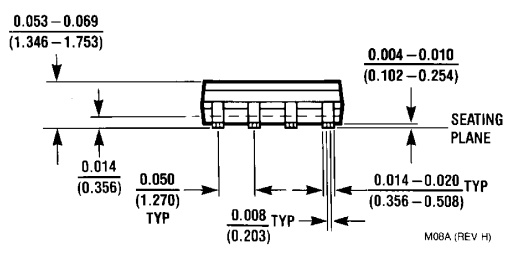
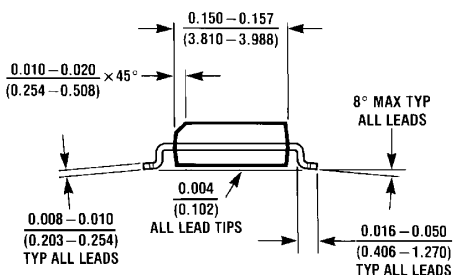
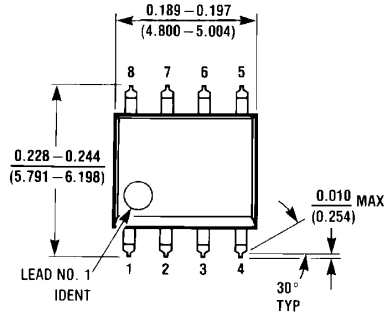

**8-Lead Small Outline Molded Package (M)
NS Package Number M08A**

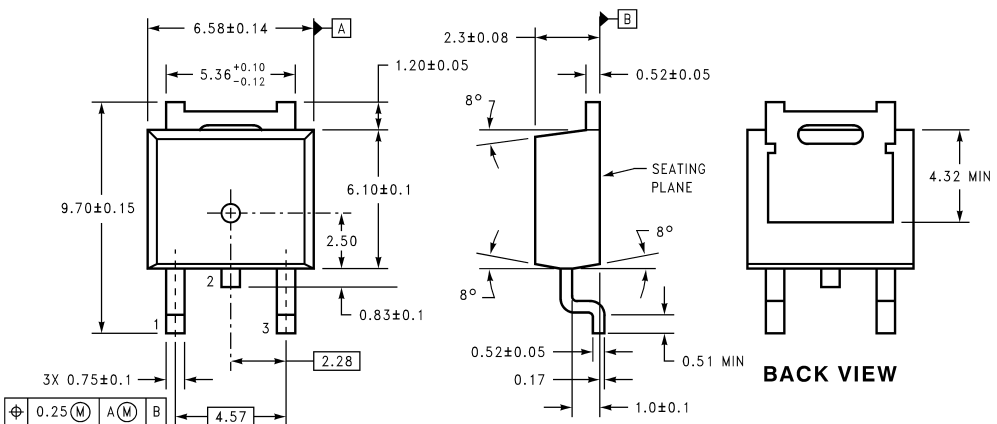

**DIMENSIONS ARE IN MILLIMETERS
TO-252 Package (DT)
NS Package Number TD03B**

TD03B (REV A)

Physical Dimensions inches (millimeters) unless otherwise noted (Continued)

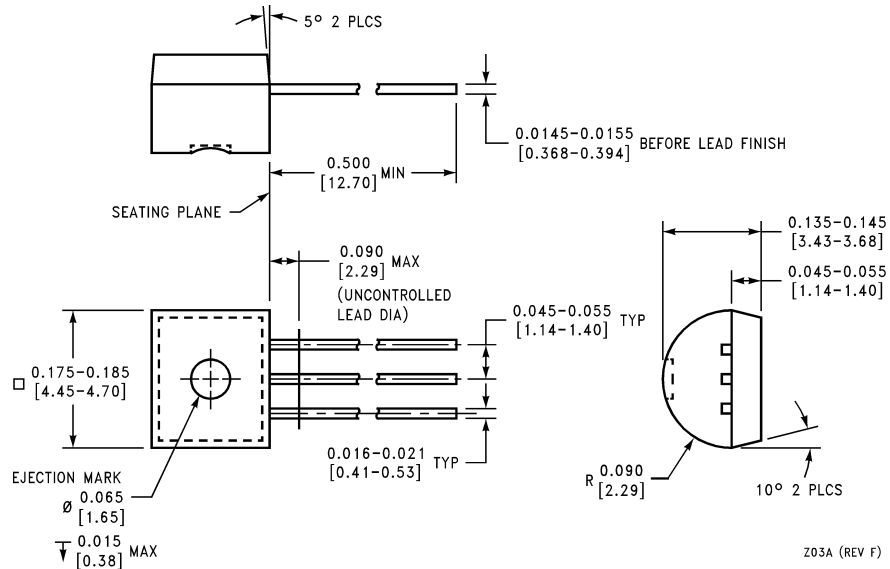

**3-Lead TO-92 Plastic Package (Z)
 NS Package Number Z03A**

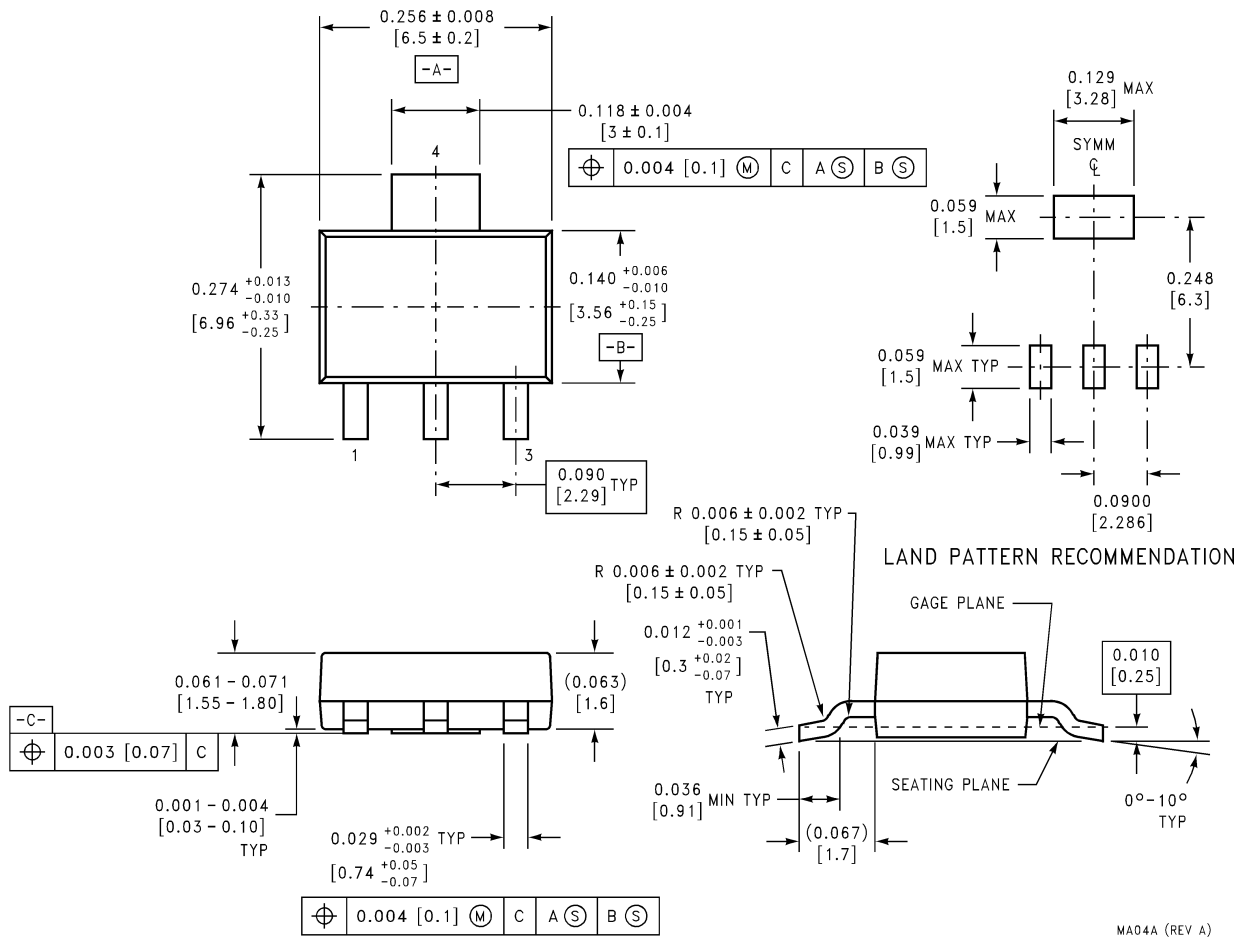

**SOT-223 Package (MP)
 NS Package Number MA04A**

Notes

LIFE SUPPORT POLICY

NATIONAL'S PRODUCTS ARE NOT AUTHORIZED FOR USE AS CRITICAL COMPONENTS IN LIFE SUPPORT DEVICES OR SYSTEMS WITHOUT THE EXPRESS WRITTEN APPROVAL OF THE PRESIDENT AND GENERAL COUNSEL OF NATIONAL SEMICONDUCTOR CORPORATION. As used herein:

1. Life support devices or systems are devices or systems which, (a) are intended for surgical implant into the body, or (b) support or sustain life, and whose failure to perform when properly used in accordance with instructions for use provided in the labeling, can be reasonably expected to result in a significant injury to the user.
2. A critical component is any component of a life support device or system whose failure to perform can be reasonably expected to cause the failure of the life support device or system, or to affect its safety or effectiveness.



National Semiconductor Corporation
Americas
Tel: 1-800-272-9959
Fax: 1-800-737-7018
Email: support@nsc.com
www.national.com

National Semiconductor Europe
Fax: +49 (0) 180-530 85 86
Email: europe.support@nsc.com
Deutsch Tel: +49 (0) 69 9508 6208
English Tel: +44 (0) 870 24 0 2171
Français Tel: +33 (0) 1 41 91 8790

National Semiconductor Asia Pacific Customer Response Group
Tel: 65-2544466
Fax: 65-2504466
Email: ap.support@nsc.com

National Semiconductor Japan Ltd.
Tel: 81-3-5639-7560
Fax: 81-3-5639-7507